

HW #2

TECH 3232

Name: _____

Due Sep 7, 2021 at start of class (paper copy)

1. Give the Boolean Expression and fill in the truth table for the following circuit:

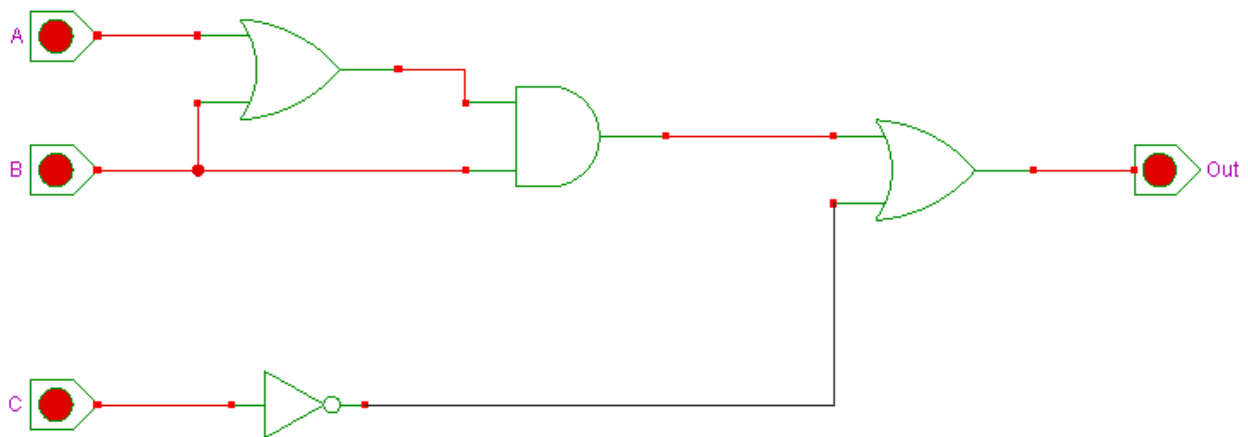

Boolean Expression:

Truth Table:

A	B	C	Out
0	0	0	
0	0	1	
0	1	0	
0	1	1	
1	0	0	
1	0	1	
1	1	0	
1	1	1	

2. Give the Boolean Expression and fill in the truth table for the following circuit:

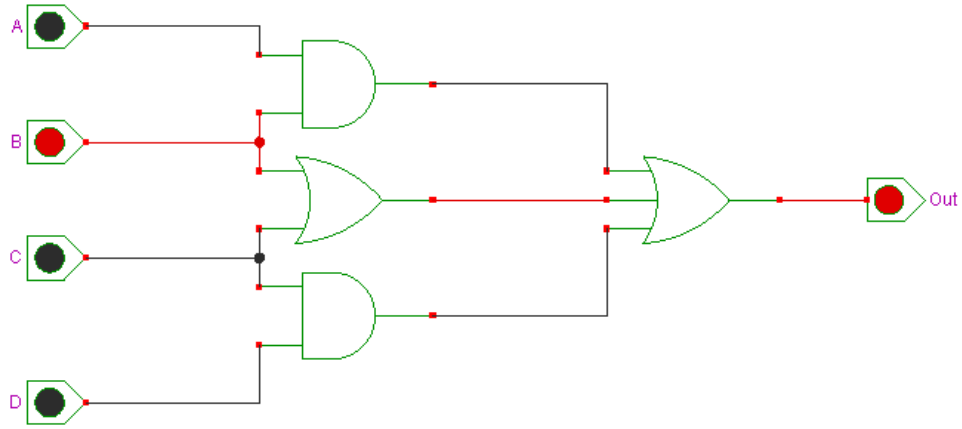

Boolean Expression:

Truth Table:

A	B	C	D	Out
0	0	0	0	
0	0	0	1	
0	0	1	0	
0	0	1	1	
0	1	0	0	
0	1	0	1	
0	1	1	0	
0	1	1	1	
1	0	0	0	
1	0	0	1	
1	0	1	0	
1	0	1	1	
1	1	0	0	
1	1	0	1	
1	1	1	0	
1	1	1	1	

